

Flat Pack

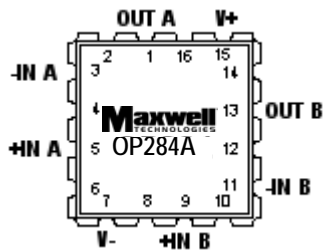

Leadless Chip Carrier (LCC)

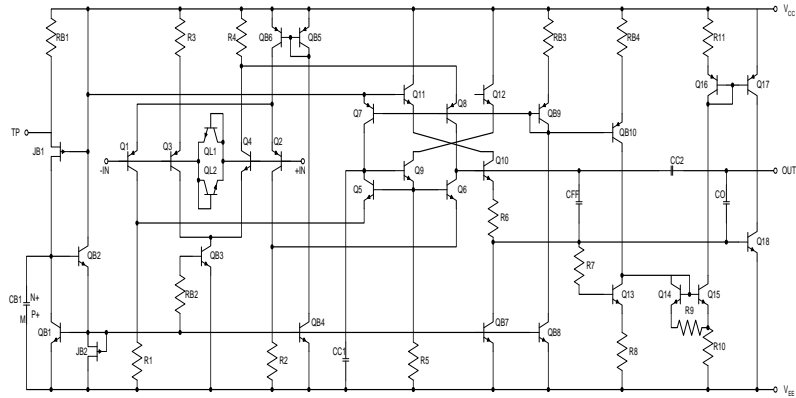

Logic Diagram

### FEATURES:

- RAD-PAK® radiation-hardened against natural space radiation
- Package:
  - 8-pin RAD-PAK® flat pack
  - 16-pin RAD-PAK® Leadless Chip Carrier (LCC) pack
- Single-Supply Operation
- Wide Bandwidth: 4 MHz
- Low Offset Voltage: 65uV
- Unity-Gain Stable
- High Slew Rate: 4.0 V/us
- Low Noise: 3.9 nV/(Hz)<sup>1/2</sup>

### DESCRIPTION:

Maxwell Technologies' OP284A is a dual single-supply, 4 MHz bandwidth amplifier featuring rail-to-rail inputs and outputs. Using Maxwell Technologies' radiation-hardened RAD-PAK® technology, it is guaranteed to operate from +3 to +36 (or ±1.5 to ±18) volts and will function with a single supply as low as +1.5 volts.

This amplifier is superb for single supply applications requiring both ac and precision dc performance. The combination of bandwidth, low noise and precision makes the OP284A useful in a wide variety of applications, including filters and instrumentation. Other applications for this amplifier include portable telecom equipment, power supply control and protection, and as an amplifier or buffer for transducers with wide output ranges.

The ability to swing rail-to-rail at both the input and output enables designers to build multi-stage filters in single-supply systems and to maintain high signal-to-noise ratios.

Maxwell Technologies' patented RAD-PAK® packaging technology incorporates radiation shielding in the microcircuit package. It eliminates the need for box shielding while providing the required radiation shielding for a lifetime in orbit or space mission. This product is available with screening up to Class S.

TABLE 1. FLAT PACK PINOUT DESCRIPTION

PIN	SYMBOL	DESCRIPTION
1, 7	OUT A, B	Outputs
2, 6	-IN A, B	Negative Inputs
3, 5	+IN A, B	Positive Inputs
4	V-	Ground
8	V+	Supply Voltage

TABLE 2. LEADLESS CHIP CARRIER (LCC) PINOUT DESCRIPTION

PIN	SYMBOL	DESCRIPTION
1, 13	OUT A, B	Outputs
3, 11	-IN A, B	Negative Inputs
5, 9	+IN A, B	Positive Inputs
7	V-	Ground
15	V+	Supply Voltage

TABLE 3. OP284A ABSOLUTE MAXIMUM RATINGS

PARAMETER	SYMBOL	MIN	MAX	UNIT
Supply Voltage	$V_{CC}$	--	$\pm 18$	V
Input Voltage	$V_I$	--	$\pm 18$	V
Differential Input Voltage <sup>1</sup>	$V_{DIF}$	--	$\pm 0.6$	V
Output Short-Circuit Duration to GND		Indefinite		
Storage Temperature	$T_S$	-65	+150	°C
Operating Temperature	$T_A$	-40	+125	°C
Junction Temperature	$T_J$	-65	+150	°C
Package Weight		--	0.75	Grams
Thermal Impedance	$\Theta_{JC}$	--	6.48	°C/W

- For input voltages greater than 0.6 volts, the input current should be limited to less 5 mA to prevent degradation or destruction of the input devices.

TABLE 4. DELTA LIMITS

PARAMETER	VARIATION
$I_{CC}$	$\pm 10\%$ of specified value in Table 5

TABLE 5. OP284A ELECTRICAL CHARACTERISTICS

(V<sub>+</sub> = 15V, V<sub>-</sub> = -15V, V<sub>OUT</sub> = 0V, R<sub>S</sub> = 50Ω, R<sub>L</sub> = 100kΩ, V<sub>CM</sub> = 0V, T<sub>A</sub> = -40°C TO +125°C UNLESS OTHERWISE SPECIFIED.)

PARAMETER	SYMBOL	TEST CONDITIONS	SUBGROUPS	MIN	TYP	MAX	UNIT
Input offset voltage	V <sub>IO</sub>	+25°C	1	-100	--	100	μV
		-40 to +125°C	2, 3	-200	--	205	
Average offset voltage drift <sup>1</sup>	V <sub>IO</sub> TC	R <sub>L</sub> = 2kΩ	1, 2, 3	--	--	2	μV/°C
Offset voltage match <sup>1</sup>	ΔV <sub>IO</sub>	V <sub>IO</sub> (max) - V <sub>IO</sub> (min) , +25°C	1	-	--	100	μV
		V <sub>IO</sub> (max) - V <sub>IO</sub> (min) , -40 to +125°C	2, 3	-	--	200	
Input bias current	I <sub>B</sub>	R <sub>S</sub> = 50Ω, +25°C	1	-350	--	350	nA
		R <sub>S</sub> = 50Ω, -40 to +125°C	2, 3	-575	--	575	nA
Input offset current	I <sub>OS</sub>	R <sub>S</sub> = 50Ω, +25°C	1	-35	--	35	nA
		R <sub>S</sub> = 50Ω, -40 to +125°C	2, 3	-50	--	50	nA
Input bias current drift <sup>1</sup>	I <sub>IBTC</sub>	R <sub>S</sub> = 50Ω	1, 2, 3	--	--	200	pA/°C
Input voltage range	I <sub>VR</sub>		1, 2, 3	-15	--	15	V
Common mode rejection ratio	CMRR	V <sub>CM</sub> = -14V to +14V	4,5,6	86	--	--	dB
		V <sub>CM</sub> = -15V to +15V, T <sub>A</sub> = 25°C	4	80	--	--	
Output current	+I <sub>O</sub>	V <sub>OUT</sub> = -10V, 1ms pulse, T <sub>A</sub> = 25°C	1	10	--	--	mA
		V <sub>OUT</sub> = -10V, 1ms pulse	2, 3	5	--	--	
	-I <sub>O</sub>	V <sub>OUT</sub> = +10V, 1ms pulse, T <sub>A</sub> = 25°C	1	--	--	-10	mA
		V <sub>OUT</sub> = -10V, 1ms pulse	2, 3	--	--	-5	
Quiescent power supply current per amplifier	+I <sub>CC</sub>	I <sub>OUT</sub> = 0mA V <sub>S</sub> = ±18V, T <sub>A</sub> = 25°C	1	--	--	1.80	mA
		I <sub>OUT</sub> = 0mA V <sub>S</sub> = ±18V	2, 3	--	--	2.25	
	-I <sub>CC</sub>	I <sub>OUT</sub> = 0mA V <sub>S</sub> = ±18V, T <sub>A</sub> = 25°C	1	-1.80	--	--	mA
		I <sub>OUT</sub> = 0mA V <sub>S</sub> = ±18V	2, 3	2.25	--	--	
Power supply rejection ratio	+PSRR	V <sub>S</sub> = ±2V to ±18V	1, 2, 3	90	--	--	dB
	-PSRR	V <sub>S</sub> = ±2V to ±18V	1, 2, 3	90	--	--	
Low frequency, peak-to-peak noise <sup>1</sup>	E <sub>np-p</sub>	0.1Hz to 10Hz, R <sub>L</sub> = 2kΩ, C <sub>L</sub> = 50pF, T <sub>A</sub> = +25°C	1	--	0.30	--	μV <sub>p-p</sub>
Input noise voltage density <sup>1</sup>	E <sub>n</sub>	R <sub>S</sub> = 20Ω, f <sub>O</sub> = 1kHz, R <sub>L</sub> = 2kΩ, C <sub>L</sub> = 50pF, T <sub>A</sub> = +25°C	1	--	3.9	--	nV/(Hz) <sup>1/2</sup>
Input noise current density <sup>1</sup>	I <sub>n</sub>	R <sub>S</sub> = 20MΩ, f <sub>O</sub> = 1kHz, R <sub>L</sub> = 2kΩ, C <sub>L</sub> = 50pF, T <sub>A</sub> = +25°C	1	--	0.4	--	pA/(Hz) <sup>1/2</sup>
Power consumption <sup>1,2</sup>	P <sub>C</sub>	+10V, I <sub>OUT</sub> = 0mA, R <sub>L</sub> = 2kΩ	1, 2, 3	--	--	81	mW
Large signal voltage gain	A <sub>VO</sub>	+10V, R <sub>L</sub> = 2.0kΩ, T <sub>A</sub> = 25°C	4	150	240	--	V/mV
		+10V, R <sub>L</sub> = 2.0kΩ, T <sub>A</sub> = 125°C	5,6	75	--	--	
Output voltage swing	+V <sub>OUT1</sub>	I <sub>L</sub> = 1.0mA	4,5,6	14.8	--	--	V
	-V <sub>OUT1</sub>	I <sub>L</sub> = 1.0mA	4,5,6	--	--	-14.8	V
Gain bandwidth product <sup>1</sup>	GBWP	V <sub>O</sub> = 200mV, R <sub>L</sub> = 2.0kΩ, C <sub>L</sub> = 50pF, T <sub>A</sub> = +25°C	4	--	4.25	--	MHz

TABLE 5. OP284A ELECTRICAL CHARACTERISTICS

(V<sub>+</sub> = 15V, V<sub>-</sub> = -15V, V<sub>OUT</sub> = 0V, R<sub>S</sub> = 50Ω, R<sub>L</sub> = 100kΩ, V<sub>CM</sub> = 0V, T<sub>A</sub> = -40°C TO +125°C UNLESS OTHERWISE SPECIFIED.)

PARAMETER	SYMBOL	TEST CONDITIONS	SUBGROUPS	MIN	TYP	MAX	UNIT
Full power bandwidth <sup>1,3</sup>	FPBW	V <sub>PEAK</sub> =29vp-p, R <sub>L</sub> =2.0kΩ, C <sub>L</sub> =50pF, T <sub>A</sub> =+25°C, 1% distortion	4	--	35	--	kHz
Settling time	t <sub>S</sub>	A <sub>V</sub> =+1.0, C <sub>L</sub> =50pF, R <sub>L</sub> =2.0kΩ To 0.01%, 10V step	9	--	--	5	μs
Phase margin	F <sub>O</sub>	A <sub>V</sub> =1.0, C <sub>L</sub> =50pF, R <sub>L</sub> =2.0kΩ, T <sub>A</sub> =+25°C	4	--	--	50	Degrees
Slew rate	+SR	C <sub>L</sub> =50pF, R <sub>L</sub> =2.0kΩ	4,5,6	2.4	4.0	--	V/μs
	-SR	C <sub>L</sub> =50pF, R <sub>L</sub> =2.0kΩ	4,5,6	2.4	4.0	--	V/μs

1. Guaranteed by design.
2. Power consumption is based upon quiescent supply current maximum test limit. No load on outputs.
3. Full power bandwidth is based on slew rate measurement using  $F_{BBW} = \text{slew rate} / (2 \cdot V_{PEAK})$ .

FIGURE 1. INPUT OFFSET VOLTAGE DISTRIBUTION

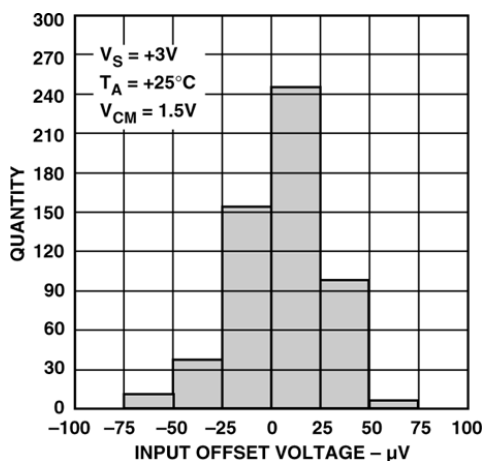

FIGURE 4. INPUT OFFSET VOLTAGE DRIFT DISTRIBUTION

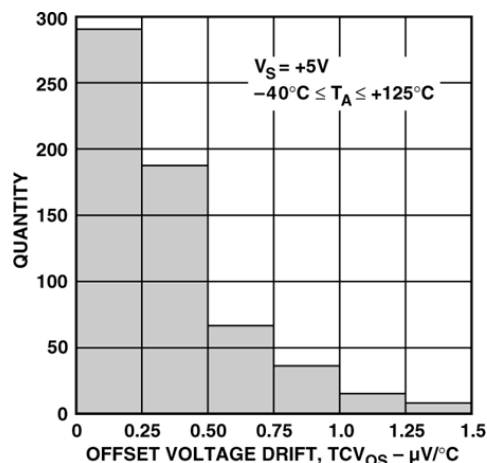

FIGURE 2. INPUT OFFSET VOLTAGE DISTRIBUTION

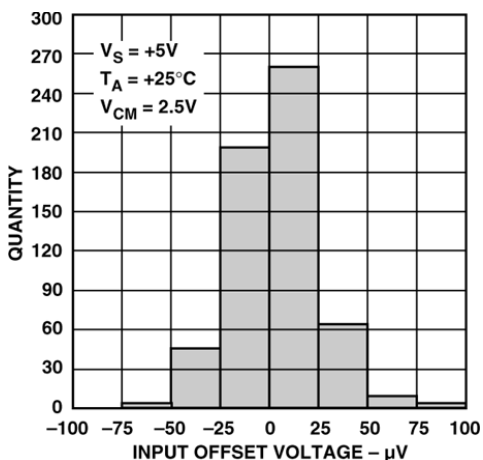

FIGURE 5. INPUT OFFSET VOLTAGE DRIFT DISTRIBUTION

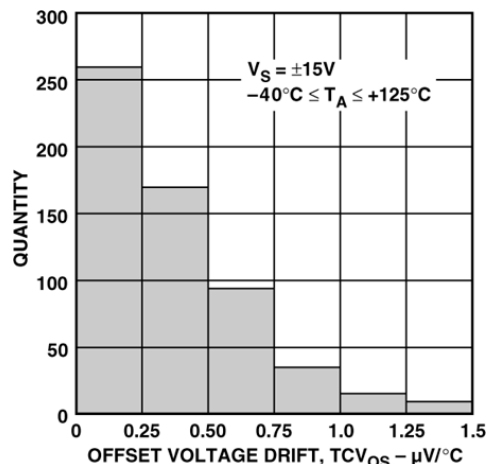

FIGURE 3. INPUT OFFSET VOLTAGE DISTRIBUTION

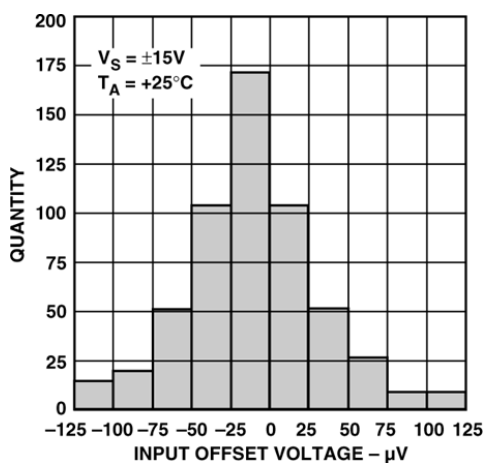

FIGURE 6. BIAS CURRENT VS. TEMPERATURE

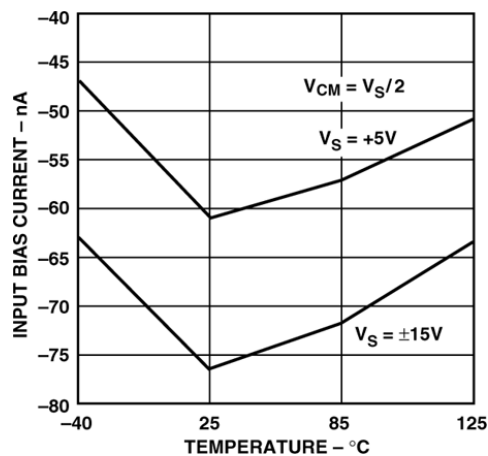

FIGURE 7. INPUT BIAS CURRENT VS. COMMON-MODE VOLTAGE

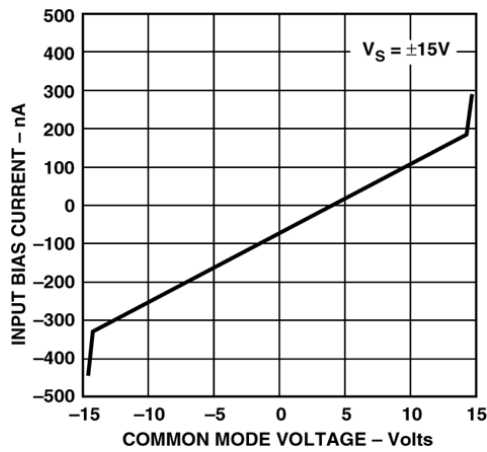

FIGURE 8. OUTPUT VOLTAGE TO SUPPLY RAIL VS. LOAD CURRENT

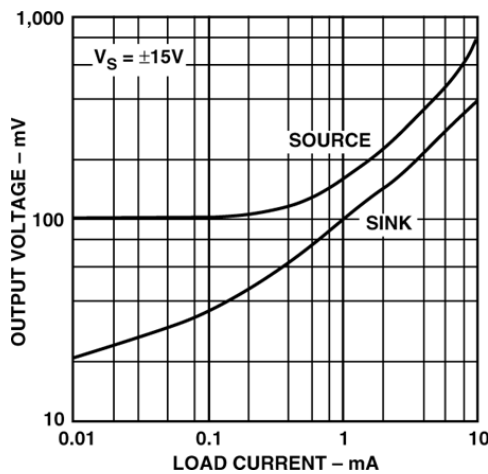

FIGURE 9. SUPPLY CURRENT VS. TEMPERATURE

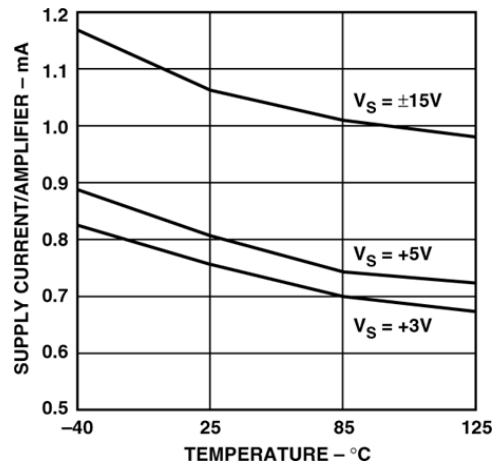

FIGURE 10. SUPPLY CURRENT VS. SUPPLY VOLTAGE

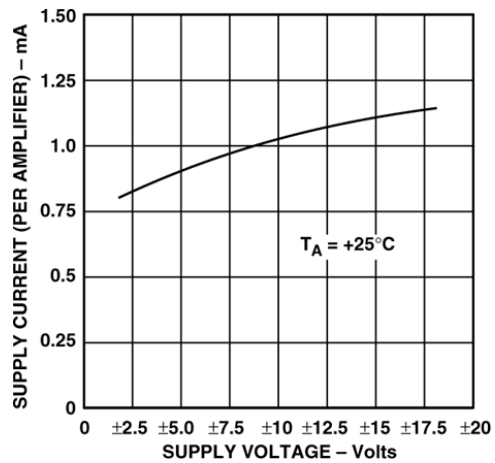

FIGURE 11. SHORT CIRCUIT CURRENT VS. TEMPERATURE

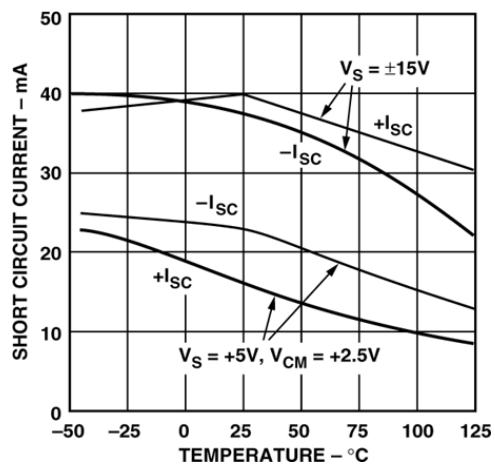

FIGURE 12. OPEN-LOOP GAIN AND PHASE VS. FREQUENCY (No Load)

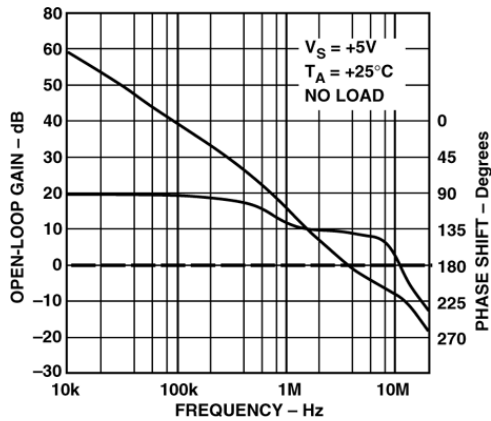

FIGURE 14. OPEN-LOOP GAIN AND PHASE VS. FREQUENCY (No Load)

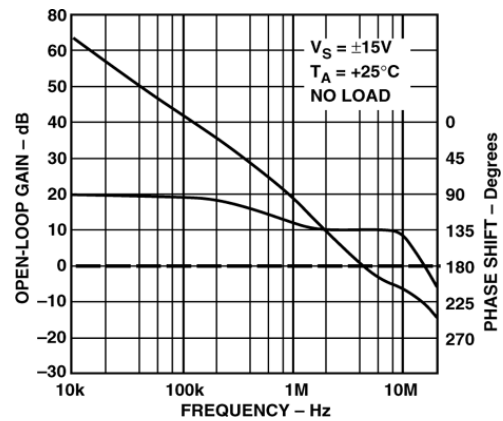

FIGURE 13. OPEN-LOOP GAIN AND PHASE VS. FREQUENCY (No Load)

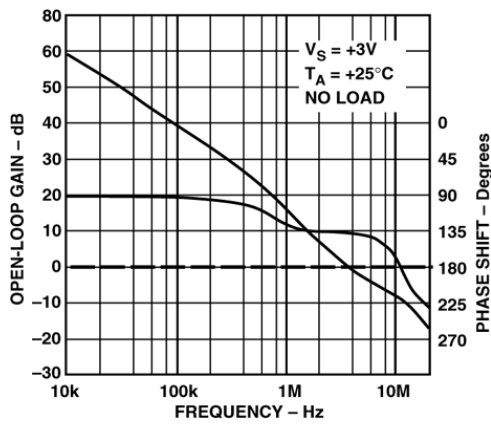

FIGURE 15. OPEN-LOOP GAIN VS. TEMPERATURE

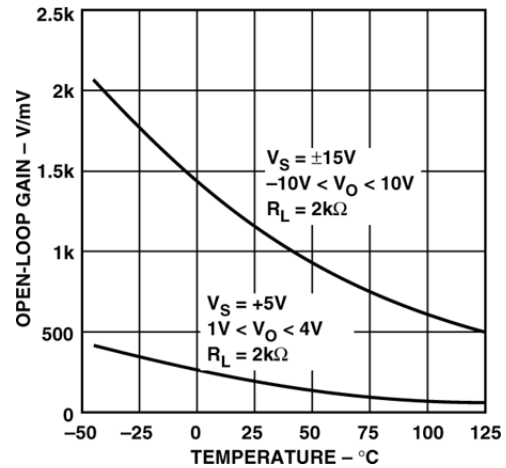

FIGURE 16. CLOSED-LOOP GAIN VS. FREQUENCY (2k $\Omega$  LOAD)

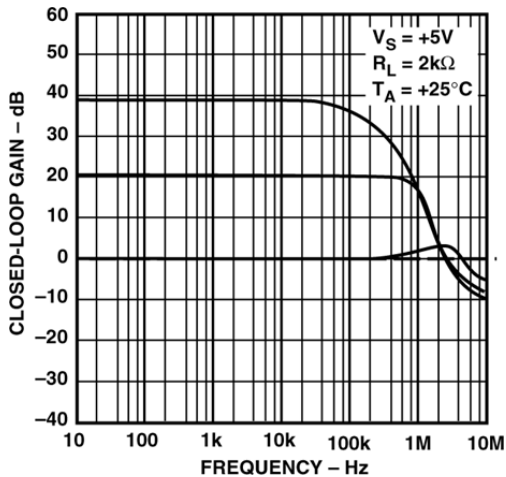

FIGURE 18. CLOSED-LOOP GAIN VS. FREQUENCY (2k $\Omega$  LOAD)

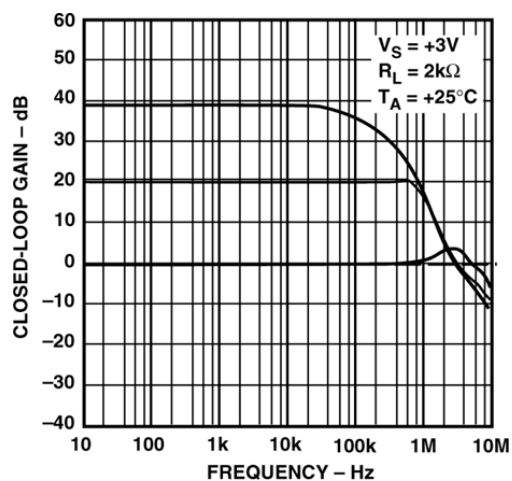

FIGURE 17. CLOSED-LOOP GAIN VS. FREQUENCY (2k $\Omega$  LOAD)

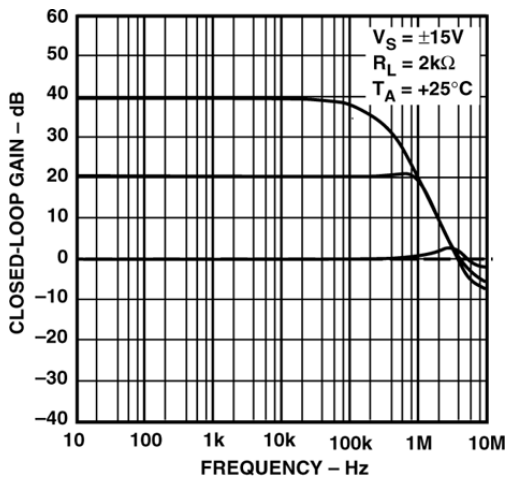

FIGURE 19. OUTPUT IMPEDANCE VS. FREQUENCY

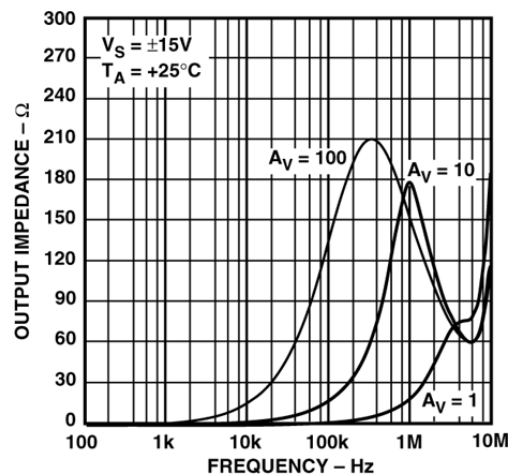



FIGURE 20. OUTPUT IMPEDANCE VS. FREQUENCY

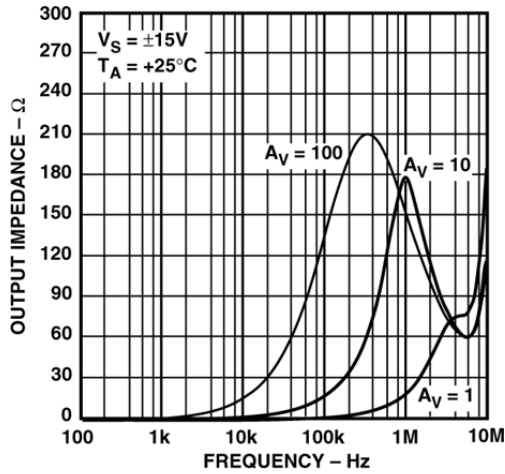

FIGURE 23. MAXIMUM OUTPUT SWING VS. FREQUENCY

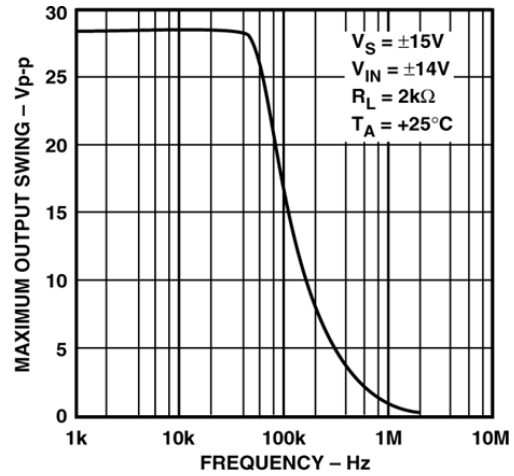

FIGURE 21. OUTPUT IMPEDANCE VS. FREQUENCY

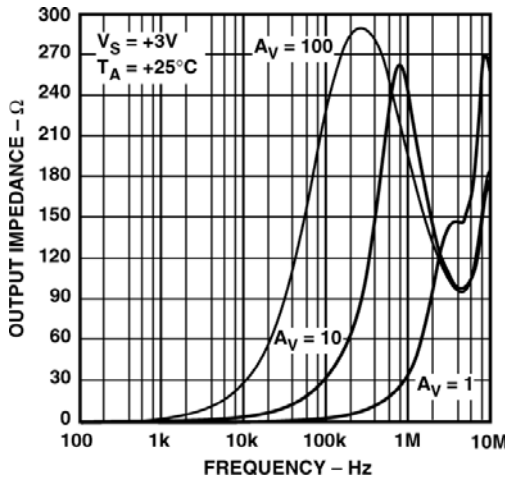

FIGURE 24. CMMR VS. FREQUENCY

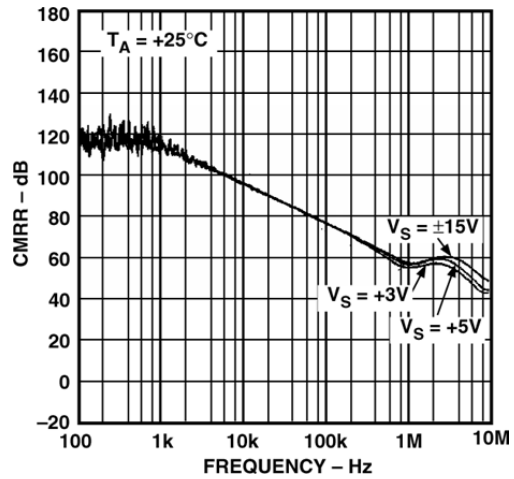

FIGURE 22. MAXIMUM OUTPUT SWING VS. FREQUENCY

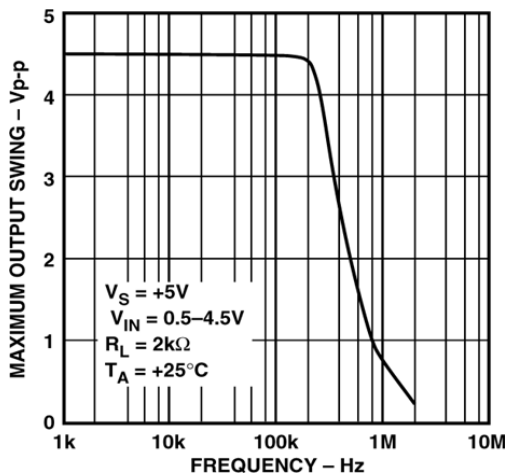

FIGURE 25. PSRR vs. FREQUENCY

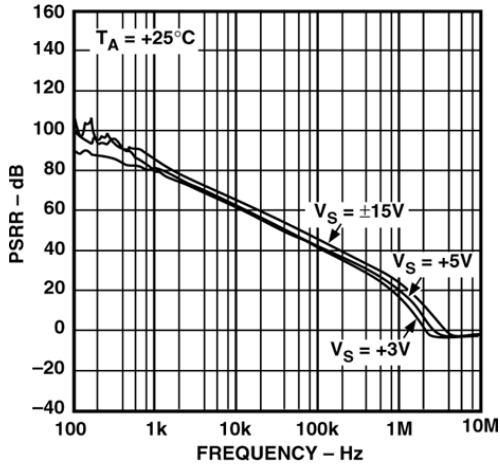

FIGURE 26. SMALL SIGNAL OVERSHOOT vs. CAPACITIVE LOAD

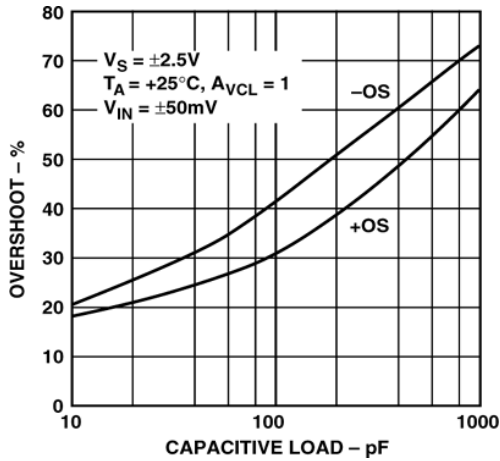

FIGURE 27. SLEW RATE vs. TEMPERATURE

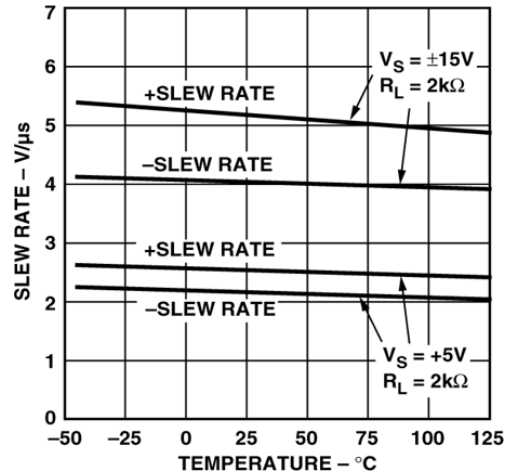

FIGURE 28. VOLTAGE NOISE DENSITY vs. FREQUENCY

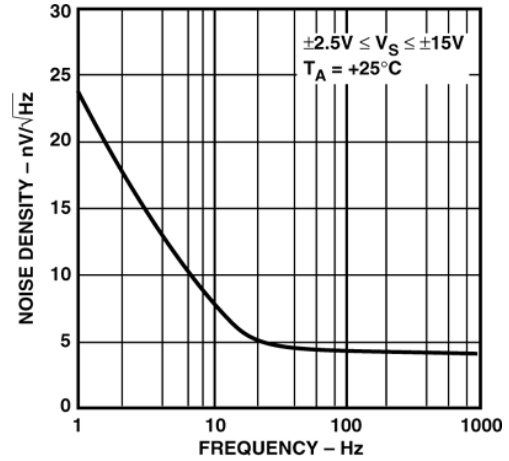

FIGURE 29. CURRENT NOISE DENSITY vs. FREQUENCY

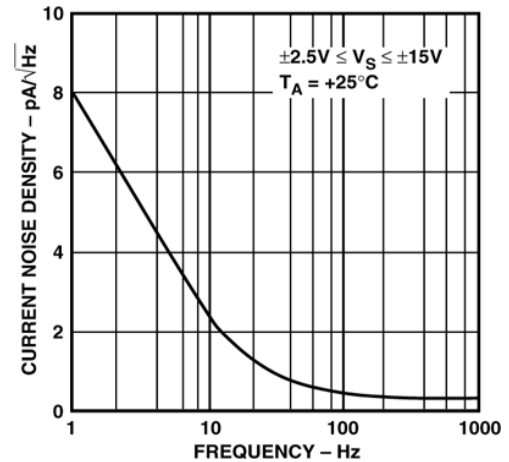

FIGURE 30. SETTLING TIME VS. STEP SIZE

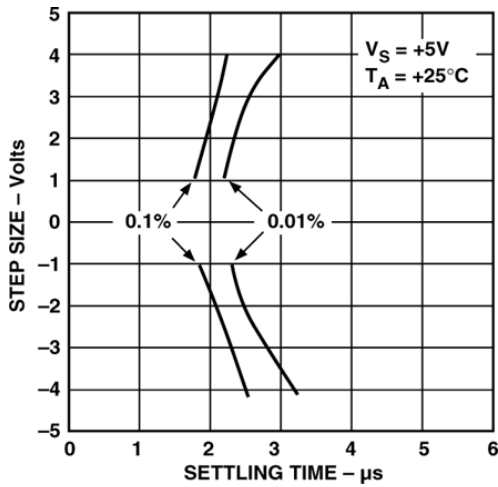

FIGURE 31. SETTLING VS. STEP SIZE

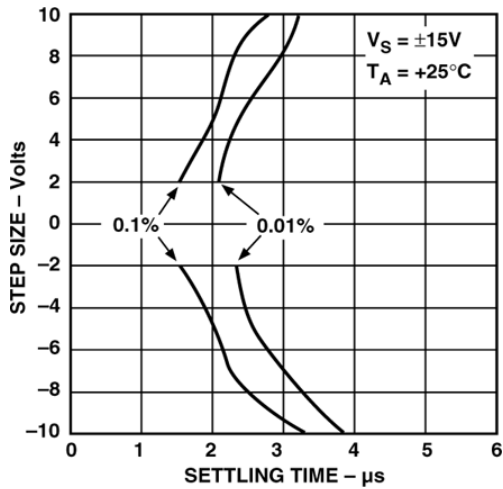

FIGURE 32. 0.1 Hz TO 10 Hz NOISE

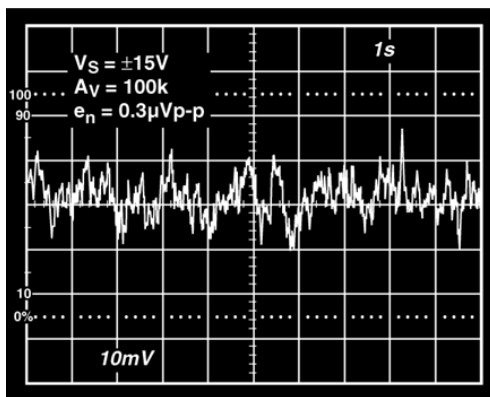

FIGURE 33. 0.1 Hz TO 10 Hz NOISE

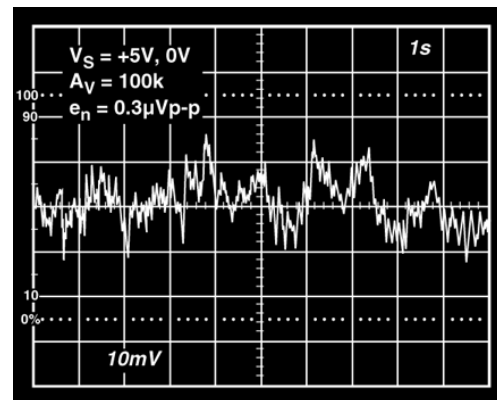

FIGURE 34. CHANNEL SEPARATION VS. FREQUENCY

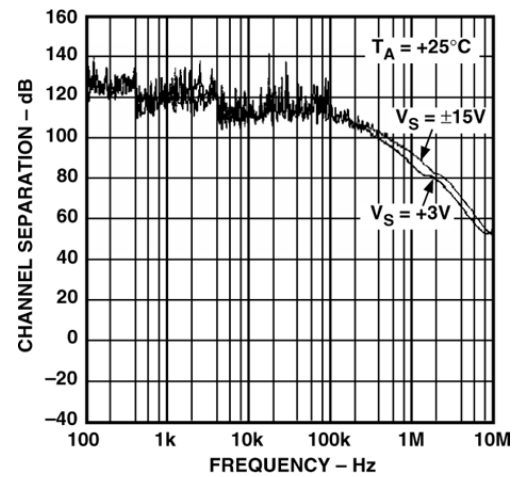

FIGURE 35. SMALL SIGNAL TRANSIENT RESPONSE

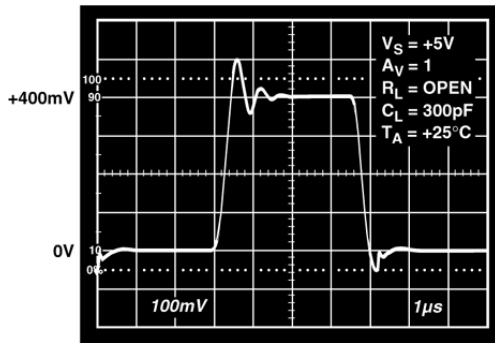

FIGURE 38. SMALL SIGNAL TRANSIENT RESPONSE

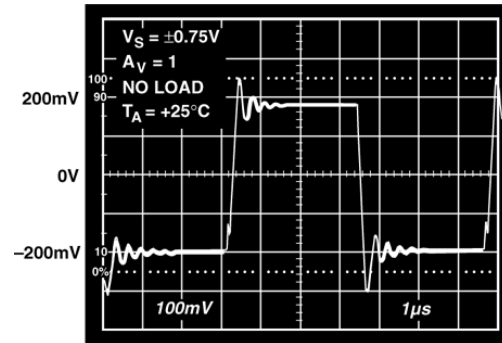

FIGURE 36. SMALL SIGNAL TRANSIENT RESPONSE

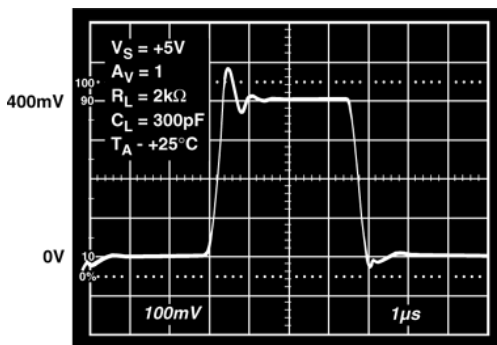

FIGURE 39. TOTAL HARMONIC DISTORTION VS. FREQUENCY

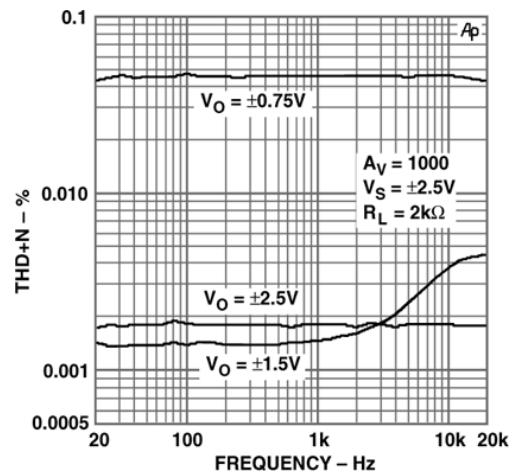
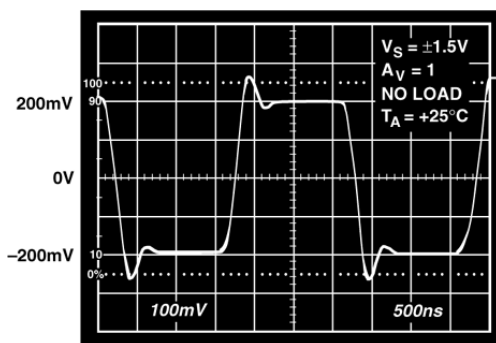
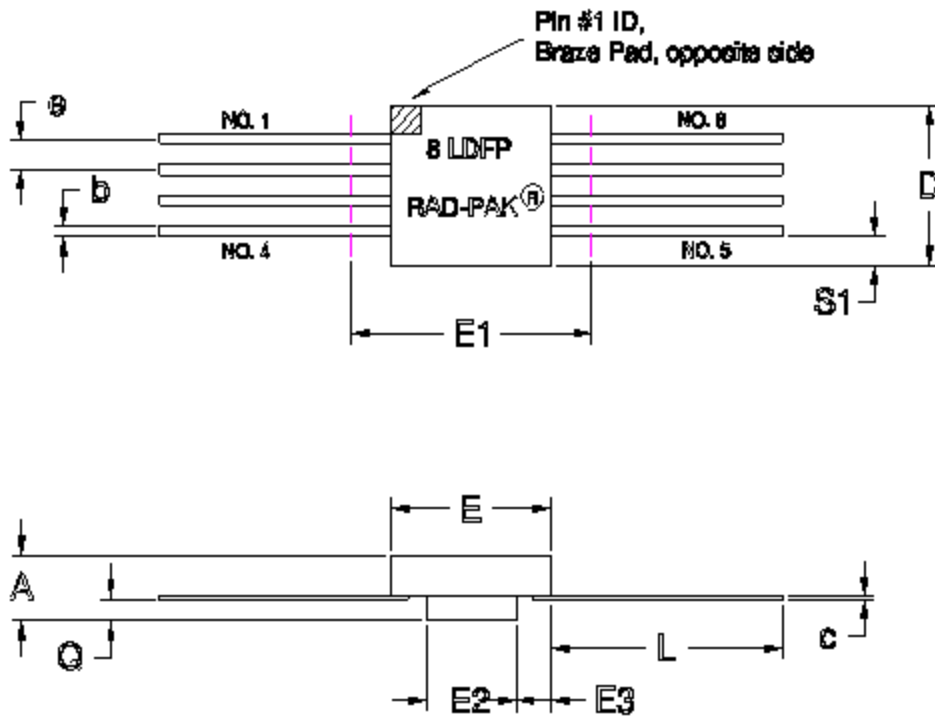

FIGURE 37. SMALL SIGNAL TRANSIENT RESPONSE





8-PIN RAD-PAK® FLAT PACKAGE

SYMBOL	DIMENSION		
	MIN	NOM	MAX
A	0.119	0.132	0.149
b	0.010	0.017	0.022
c	0.004	0.005	0.009
D	0.250	0.255	0.260
E	0.250	0.255	0.260
E1	--	--	0.290
E2	0.125	0.145	--
E3	0.030	0.040	--
e	0.050 BSC		
L	0.338	0.348	0.358
Q	0.021	0.025	0.045
S1	0.005	0.019	--
N	8		

Note: All dimensions in inches

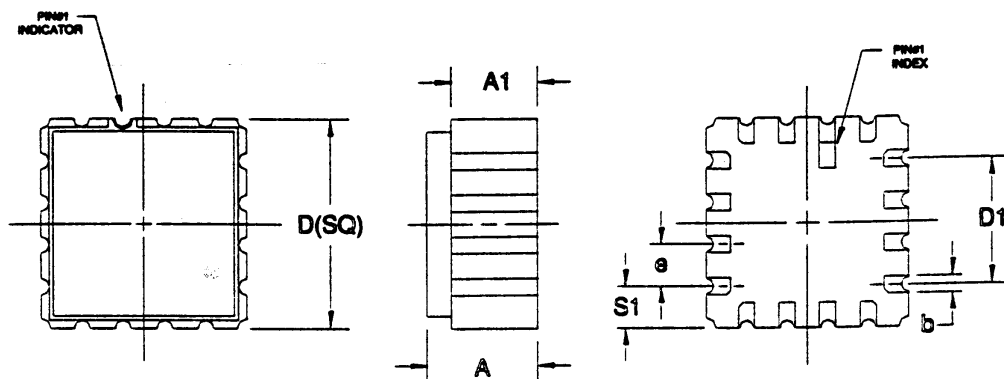

16-PIN RAD-PAK® LCC PACKAGE

SYMBOL	DIMENSION		
	MIN	NOM	MAX
A	0.123	0.135	0.150
b	0.018	0.020	0.025
D	0.245	0.250	0.260
D1	0.150 BSC		
S1	0.050 BSC		
e	0.050 BSC		
A1	0.095	0.105	0.116
N	16		

Note: All dimensions in inches.

## Important Notice:

These data sheets are created using the chip manufacturer's published specifications. Maxwell Technologies verifies functionality by testing key parameters either by 100% testing, sample testing or characterization.

The specifications presented within these data sheets represent the latest and most accurate information available to date. However, these specifications are subject to change without notice and Maxwell Technologies assumes no responsibility for the use of this information.

Maxwell Technologies' products are not authorized for use as critical components in life support devices or systems without express written approval from Maxwell Technologies.

Any claim against Maxwell Technologies must be made within 90 days from the date of shipment from Maxwell Technologies. Maxwell Technologies' liability shall be limited to replacement of defective parts.

# Dual Operational Amplifier

# OP284A

## Product Ordering Options

