

Logic Diagram

FEATURES:

- Detects ionizing radiation pulses
- Tested/certified detection threshold level
- Adjustable circumvention period
- 100% testable with built-in test
- Detection threshold adjustability
- Single +5V operation
- Designed-in radiation hardness
- Compliant to MIL-PRF-38534 Class H¹
- Flat pack (F) or DIP (L) packages

RADIATION HARDNESS CHARACTERISTICS

- Dose Rate (operate-through): 1×10^{12} rad(Si)/sec
- Total Dose: 1×10^6 rad(Si)
- Neutron Fluence: 5×10^{13} n/cm²
- Approximate Detection Range: 2×10^5 - 2×10^7 rad(Si)/sec
- Maxwell Technologies Specified, Controlled, and Tested

DESCRIPTION:

Maxwell Technologies' HSN-500 radiation-hardened Hybrid Nuclear Event Detector (NED) senses ionizing radiation pulses generated by a nuclear event, such as the detonation of a nuclear weapon, and rapidly switches its output from the normal high state to a low state with a propagation delay time of less than 20 ns. The active low Nuclear Event Detection signal (NED) is used to initiate a wide variety of circumvention functions, thus preventing upset and burnout of electronic components. The NED output is also used to initiate both hardware and software recovery. This high-speed, 14-pin hybrid detector is used in electronic systems as a general-purpose circumvention device to protect memory, stop data processing, and drive power supply switches as well as signal clamps.

The HSN-500 is designed to operate through three critical environments: ionizing dose rate [10^{12} rad(Si)/s], gamma total dose [10^6 rad(Si)], and neutron fluence [5×10^{13} n/cm²]. In addition, the device is designed to function throughout the transient neutron pulse. The hybrid's discrete design ensures a controlled response in these radiation environments as well as immunity to latchup. The detection level and functionality of a sample of each HSN-500 production lot are tested in an ionizing dose rate environment. A certificate is provided reporting the test results for the production lot.

The detection threshold of the HSN-500 is adjustable within the range of 2×10^5 rad(Si)/s to 2×10^7 rad(Si)/s. This detection level can be preset by Maxwell or adjusted by the user. Less than a 30% variation in detection threshold can be expected over the entire operating temperature range.

1. Manufactured for Maxwell Technologies by Teledyne Microelectronic Technologies to MIL-PRF-38534, Class H, no RHA

TABLE 1. PIN DESCRIPTION

PIN NUMBER	PIN FUNCTION
1	Load Voltage, V_L
2	Nuclear Event Detector, NED
3	No Connection
4	External Capacitor
5	External Capacitor
6	Built In Test, BIT
7	Package Ground and Case
8	PIN Diode Bias, V_B
9	Threshold Adjust
10	No Connection
11	No Connection
12	No Connection
13	No Connection
14	Hardened Supply Voltage, V_H

TABLE 2. ELECTRICAL CHARACTERISTICS

PARAMETER	SYMBOL	CONDITIONS $-55^{\circ}\text{C} \leq T_A \leq 125^{\circ}\text{C}$	MIN	MAX	UNIT	GROUP A SUBGROUP
Hardened Supply Voltage	V_H		4.5	5.5	V	1,2,3
Hardened Supply Current - Standby ¹ - Operational ²	I_H	$V_H = 5.5\text{V}$	-- --	-- 30 120	mA	1,2,3
Load Voltage	V_L		--	20	V	1,2,3
Load Current - Standby ¹ - Operational ²	I_L	$V_L = 20\text{V}$	-- --	100 2.25	μA mA	1,2,3
PIN Diode Bias Voltage - Standby ¹	V_B		4.5	20	V	1,2,3
PIN Diode Bias Current - Standby ¹	I_B		--	100	μA	1,2,3
Built-In-Test (BIT) ^{3,4}	V_{IH}	$V_{IH} = 4.0\text{V}$ $V_{IL} = 0.5\text{V}$ Pin 9 Open, $V_{IH} = 4.0\text{V}$	4.0	5.5	V	7,8
	I_{IH}		--	25	mA	1,2,3
	V_{IL}		--	0.5	V	7,8
	I_{IL}		--	10	μA	1,2,3
	t_{PW}		10	--	μs	9,10,11
NED	V_{OH}	$V_L = 20\text{V}$, $I_{OH} = -100\ \mu\text{A}$ $I_{OL} = 10\ \text{mA}$ $I_{OL} = 100\ \text{mA}$	18.5	--	V	1,2,3
	V_{OL}		--	0.6		1,2,3
			--	1.0		
Radiation Propagation Delay Time ⁵	t_D		--	20	ns	

Table 2. Notes

1. Standby mode is the normal state of the device, defined as having the $\overline{\text{NED}}$ output (pin 2) in the "high" state.
2. Operational mode is in effect during the timeout period of the NED signal, characterized by having the NED output in the "low" state, causing the greatest current draw of the device.
3. BIT electrical characteristics are not guaranteed over the radiation range.
4. BIT may not meet specification when only a resistor is used to adjust the detection level. To use BIT in this situation, it is advised that a series resistor/capacitor combination is used.
5. Guaranteed but not tested over temperature. Time delay, t_D , is measured at 50% points from the rising edge of the radiation pulse to the falling edge of the $\overline{\text{NED}}$ output at approximately 10 times the detection level.

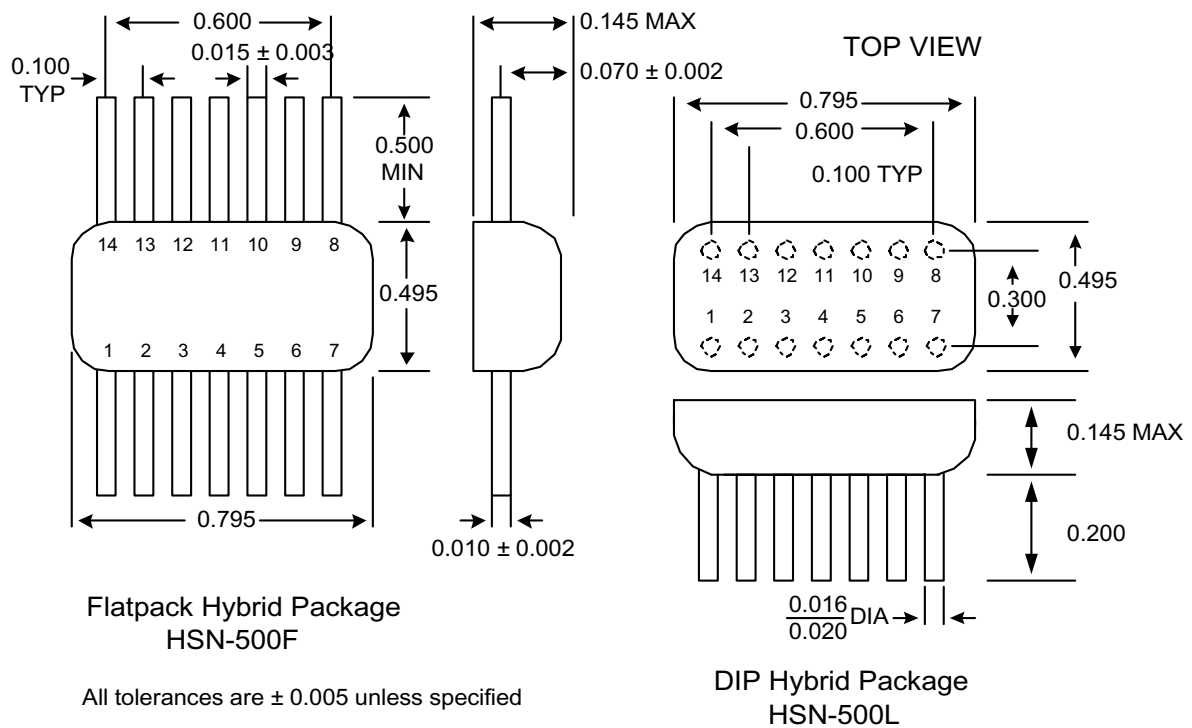

MECHANICAL DIMENSIONS
Note: All dimensions in inches.

Important Notice:

The specifications presented within these data sheets represent the latest and most accurate information available to date. However, these specifications are subject to change without notice and Maxwell Technologies assumes no responsibility for the use of this information.

Maxwell Technologies' products are not authorized for use as critical components in life support devices or systems without express written approval from Maxwell Technologies.

Any claim against Maxwell Technologies must be made within 90 days from the date of shipment from Maxwell Technologies. Maxwell Technologies' liability shall be limited to replacement of defective parts.

Product Ordering Options

