

Logic Diagram

FEATURES:

- RAD-PAK® Technology
- - Total Dose Hardness > 100 Krads(Si)
- Package:
 - 8 Pin RAD-PAK® Flat Package
- Excellent TCV_{OS}
-21 μ V/C MAX
- Low Input Offset Voltage:
-150mV Max
- Low Supply Current:
-100 μ A
- Single Supply Operation:
+5 to +30 Volts
- Low Input Offset Voltage Drift
-0.75 μ V/C
- High Open Loop Gain:
-2000V/mV
- Low Input Bias Current
- Wide Common Mode Voltage Range

DESCRIPTION: The OP220RP (RP for RAD-PAK®) monolithic dual operational amplifier microcircuit features a minimum 100 kilorad (Si) total dose tolerance. Using Maxwells radiation hardened RAD-PAK® packaging technology, the OP220RP can be used either in single or dual supply operation. The OP220RP is the first micropower precision dual operational amplifier capable of surviving space environments. The OP220RP is ideal for satellite, spacecraft, and space probe missions. The patented radiation hardened RAD-PAK® technology incorporates radiation shielding in the microcircuit package. It eliminates the need for box shielding while providing a lifetime in orbit. This product is available in Class E, I, B and S screening.

TABLE 1. OP220 PINOUT DESCRIPTION

PIN	SYMBOL	DESCRIPTION
1	Out A	Output Amplifier A
2	-IN A	Inverting Input Amplifier A
3	+ IN A	Non-Inverting Input Amplifier A
4	-V	Negative Supply Voltage
5	+ IN B	Non-Inverting Input Amplifier B
6	-IN B	Inverting Input Amplifier B
7	Out B	Output Amplifier B
8	+V	Positive Supply Voltage

TABLE 2. OP220 ABSOLUTE MAXIMUM RATINGS

PARAMETER	SYMBOL	MIN	MAX	UNIT
Supply Voltage		--	±18	V
Differential Input Voltage		--	30	V
Input Voltage	V_I	--	Supply Voltage	V
Output Short-Circuit Duration		Indefinite		
Power Dissipation	P_D		500	mW
Storage Temperature Range	T_S	-65	150	°C
Operating Temperature Range	T_A	-55	125	°C

TABLE 3. DELTA LIMITS

PARAMETER	VARIATION
I_{SY}	±10% of specified value in Table 4

TABLE 4. OP220 ELECTRICAL CHARACTERISTICS
($V_S = \pm 2.5V$ TO $\pm 15V$, $T_A = -55$ TO $+125^\circ C$, UNLESS OTHERWISE SPECIFIED)

PARAMETER	SYMBOL	TEST CONDITIONS	SUBGROUPS	MIN	TYP	MAX	UNITS
Supply Current Both Amplifiers	I_{SY}	$V_S = \pm 2.5V$, No Load $V_S = \pm 15V$, No Load	1, 2, 3	-- --	135 190	170 250	uA
Common-Mode Rejection Ratio	CMRR	$V_S = \pm 15V$ $T_A = 25^\circ C$	4	90	100		dB
Power Supply Rejection Ratio	PSRR	$V_S = \pm 2.5V$ TO $V_S = \pm 15V$ $T_A = 25^\circ C$	1, 2, 3	--	6	18	uV/V

TABLE 4. OP220 ELECTRICAL CHARACTERISTICS
 ($V_S = \pm 2.5V$ TO $\pm 15V$, $T_A = -55$ TO $+125^\circ C$, UNLESS OTHERWISE SPECIFIED)

PARAMETER	SYMBOL	TEST CONDITIONS	SUBGROUPS	MIN	TYP	MAX	UNITS
Input Offset Voltage	V_{OS}	$V_S = \pm 15V$	1, 2, 3		120	300	μV
Input Offset Voltage Drift	TCV_{OS}	$V_S = \pm 15V$	1, 2, 3		0.75	--	$\mu V/^\circ C$
Input Offset Current	I_{OS}	$V_{CM} = 0$	1, 2, 3	--	0.5	2	nA
Input Offset Current Drift		$R_S = 0\Omega$	1, 2, 3	--	10	--	$pA/^\circ C$
Input Bias Current	I_B	$V_{CM} = 0$	1, 2, 3	--	12	20	nA
Input Common-Mode Voltage Range	I_{VR}	$V_S = \pm 15V$	1, 2, 3	-15		13.2	V
Large Signal Voltage Gain	A_{VO}	$V_S = \pm 15V$ $V_O = \pm 10V$ $R_L = 50K\Omega$	1, 2, 3	500	1000		V/mV
Output Voltage Swing	V_O	$V_S = \pm 15V, R_L = 50K\Omega$	1, 2, 3	-13.8	--	13.8	V

Typical Performance Characteristics

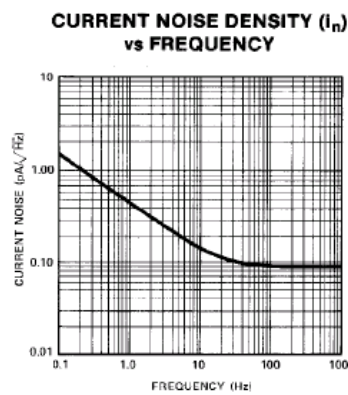
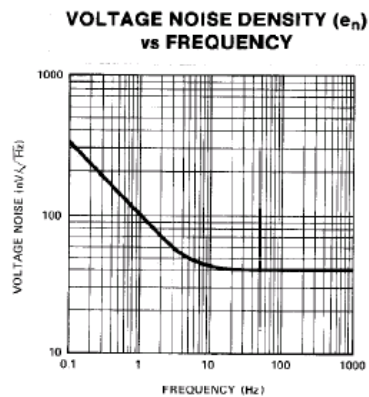
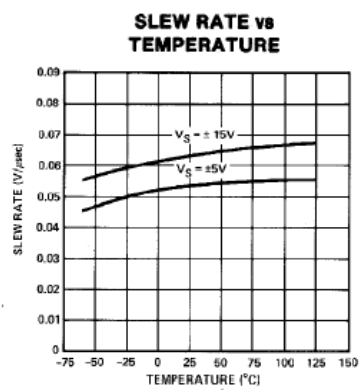
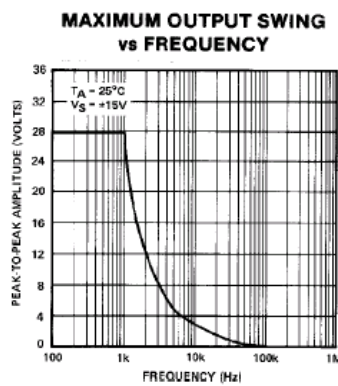
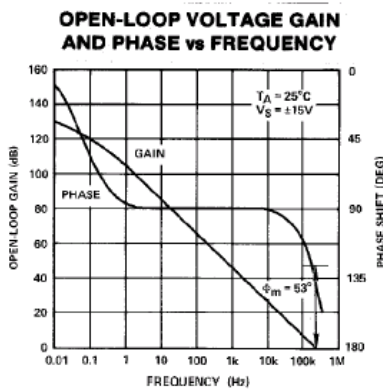

Typical Performance Characteristics

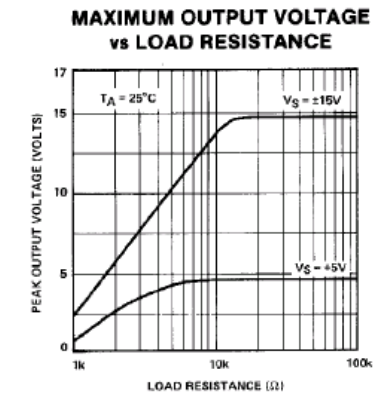
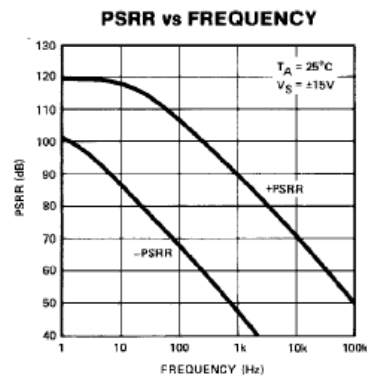
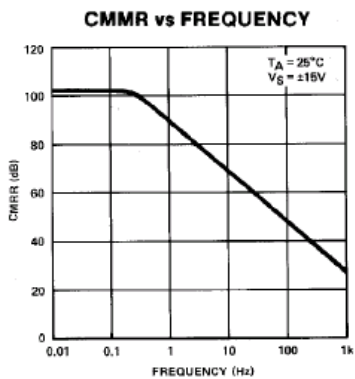
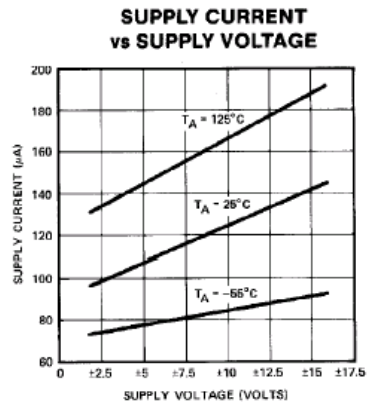
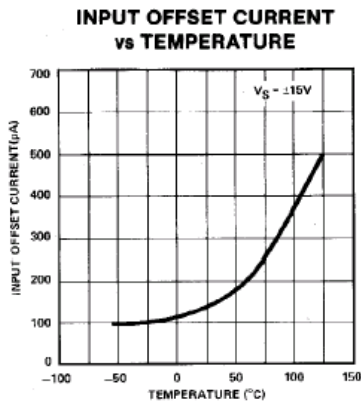
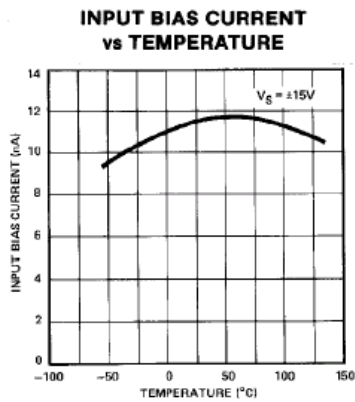
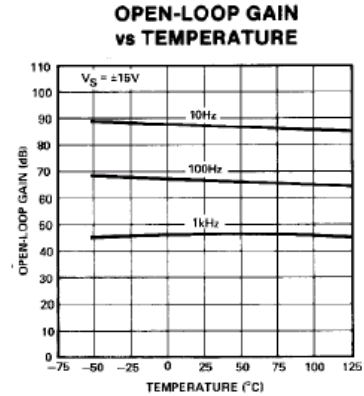
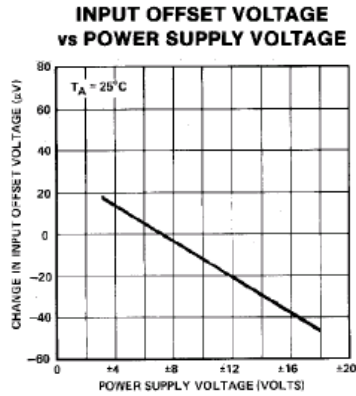
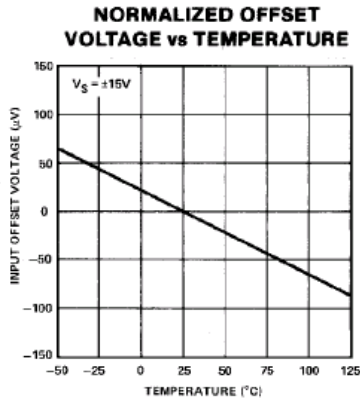

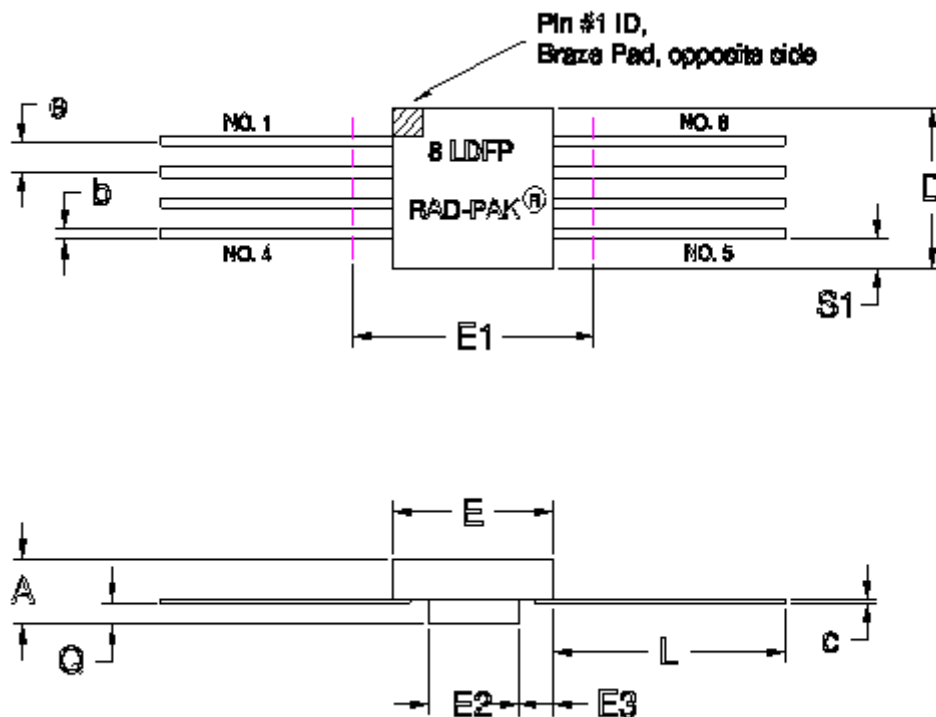

8-PIN RAK-PAK® FLAT PACKAGE

SYMBOL	DIMENSION		
	MIN	NOM	MAX
A	0.119	0.132	0.149
b	0.010	0.017	0.022
c	0.004	0.005	0.009
D	0.250	0.255	0.260
E	0.250	0.255	0.260
E1	--	--	0.290
E2	0.125	0.145	0.150
E3	0.045	0.055	--
e	0.050 BSC		
L	0.338	0.348	0.358
Q	0.021	0.025	0.045
S1	0.005	0.019	--
N	8		

F8-01

Note: All dimensions in inches.

Important Notice:

These data sheets are created using the chip manufacturer's published specifications. Maxwell Technologies verifies functionality by testing key parameters either by 100% testing, sample testing or characterization.

The specifications presented within these data sheets represent the latest and most accurate information available to date. However, these specifications are subject to change without notice and Maxwell Technologies assumes no responsibility for the use of this information.

Maxwell Technologies' products are not authorized for use as critical components in life support devices or systems without express written approval from Maxwell Technologies.

Any claim against Maxwell Technologies must be made within 90 days from the date of shipment from Maxwell Technologies. Maxwell Technologies' liability shall be limited to replacement of defective parts.

Product Ordering Options

